

**New**



**Compliance with RoHS Directive**

\* Protective construction: Flux-resistant type

**FEATURES**

1. Latching type that contributes to device energy savings
2. Surge breakdown voltage (between contact and coil): 12,000 V
3. Breakdown voltage (between contact and coil): 5,000 V
4. Pin-in-paste construction makes reflow possible

**TYPICAL APPLICATIONS**

1. Smart meters
2. Industrial equipment
3. Security equipment
4. Home appliances
5. Various power supplies

**ORDERING INFORMATION**

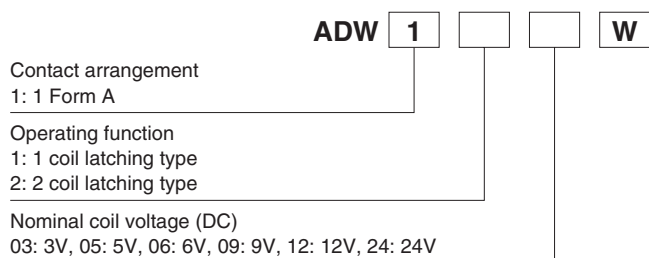

Note: The suffix "W" on the part number is only displayed on the inner and outer packaging. It is not displayed on the relay.

**TYPES**

| Contact arrangement | Nominal coil voltage | Part No.             |                      |
|---------------------|----------------------|----------------------|----------------------|
|                     |                      | 1 coil latching type | 2 coil latching type |
| 1 Form A            | 3V DC                | ADW1103W             | ADW1203W             |
|                     | 5V DC                | ADW1105W             | ADW1205W             |
|                     | 6V DC                | ADW1106W             | ADW1206W             |
|                     | 9V DC                | ADW1109W             | ADW1209W             |
|                     | 12V DC               | ADW1112W             | ADW1212W             |
|                     | 24V DC               | ADW1124W             | ADW1224W             |

Standard packing: Carton: 100 pcs.; Case: 500 pcs.

# DW (ADW1)

## RATING

### 1. Coil data

#### 1) 1 coil latching type

| Nominal coil voltage | Set voltage (at 20°C 68°F)                 | Reset voltage (at 20°C 68°F)               | Nominal operating current [±10%] (at 20°C 68°F) | Coil resistance [±10%] (at 20°C 68°F) | Nominal operating power | Max. applied voltage (at 20°C 68°F) |
|----------------------|--|--|---|---------------------------------------|-------------------------|-------------------------------------|
| 3V DC                | *80%V or less of nominal voltage (Initial) | *80%V or less of nominal voltage (Initial) | 66.7mA  | 45Ω                                   | 200mW                   | 110%V of nominal voltage            |
| 5V DC                |  |  | 40.0mA  | 125Ω                                  |                         |                                     |
| 6V DC                |  |  | 33.3mA  | 180Ω                                  |                         |                                     |
| 9V DC                |  |  | 22.2mA  | 405Ω                                  |                         |                                     |
| 12V DC               |  |  | 16.7mA  | 720Ω                                  |                         |                                     |
| 24V DC               |  |  | 8.3mA   | 2,880Ω                                |                         |                                     |

#### 2) 2 coil latching type

| Nominal coil voltage | Set voltage (at 20°C 68°F)                 | Reset voltage (at 20°C 68°F)               | Nominal operating current [±10%] (at 20°C 68°F) |            | Coil resistance [±10%] (at 20°C 68°F) |            | Nominal operating power |            | Max. applied voltage (at 20°C 68°F) |
|----------------------|--|--|---|------------|---------------------------------------|------------|-------------------------|------------|-------------------------------------|
|                      |  |  | Set coil  | Reset coil | Set coil                              | Reset coil | Set coil                | Reset coil |                                     |
| 3V DC                | *80%V or less of nominal voltage (Initial) | *80%V or less of nominal voltage (Initial) | 133.3mA   | 133.3mA    | 22.5Ω                                 | 22.5Ω      | 400mW                   | 400mW      | 110%V of nominal voltage            |
| 5V DC                |  |  | 80.0mA  | 80.0mA     | 62.5Ω                                 | 62.5Ω      |                         |            |                                     |
| 6V DC                |  |  | 66.7mA  | 66.7mA     | 90 Ω                                  | 90 Ω       |                         |            |                                     |
| 9V DC                |  |  | 44.4mA  | 44.4mA     | 202.5Ω                                | 202.5Ω     |                         |            |                                     |
| 12V DC               |  |  | 33.3mA  | 33.3mA     | 360 Ω                                 | 360 Ω      |                         |            |                                     |
| 24V DC               |  |  | 16.7mA  | 16.7mA     | 1,440 Ω                               | 1,440 Ω    |                         |            |                                     |

\*Pulse drive (JIS C 5442-1996)

## 2. Specifications

| Characteristics            | Item  | Specifications  |  |
|----------------------------|---|---|--|
| Contact                    | Arrangement   | 1 Form A  |  |
|                            | Contact resistance (Initial)  | Max. 100 mΩ (By voltage drop 6 V DC 1A)   |  |
|                            | Contact material  | AgSnO <sub>2</sub> type   |  |
| Rating                     | Nominal switching capacity (resistive load)                                     | 8 A 250V AC   |  |
|                            | Max. switching power (resistive load)   | 2,000 V A   |  |
|                            | Max. switching voltage  | 250V AC   |  |
|                            | Max. switching current  | 8A AC   |  |
|                            | Nominal operating power   | 200mW (1 coil latching type), 400mW (2 coil latching type)  |  |
|                            | Min. switching capacity (Reference value)*1                                     | 100mA 5 V DC  |  |
| Electrical characteristics | Insulation resistance (Initial)   | Min. 1,000MΩ (at 500V DC, Measurement at same location as "Breakdown voltage" section)  |  |
|                            | Breakdown voltage (Initial)   | Between open contacts   | 1,000 Vrms for 1min. (Detection current: 10mA)                                   |
|                            |   | Between contact and coil  | 5,000 Vrms for 1min. (Detection current: 10mA)                                   |
|                            | Temperature rise (coil) (at 85°C 185°F)   | Max. 35°C 95°F (By resistive method, contact carrying current: 8A, Coil: de-energized)  |  |
|                            | Surge breakdown voltage*2 (Between contact and coil)                            | 12,000 V (Initial)  |  |
|                            | Set time (at 20°C 68°F)   | Max. 15 ms (Nominal voltage applied to the coil, excluding contact bounce time)   |  |
| Reset time (at 20°C 68°F)  | Max. 15 ms (Nominal voltage applied to the coil, excluding contact bounce time) |   |  |
| Mechanical characteristics | Shock resistance  | Functional  | 100 m/s <sup>2</sup> (Half-wave pulse of sine wave: 11 ms; detection time: 10μs) |
|                            |   | Destructive   | 1,000 m/s <sup>2</sup> (Half-wave pulse of sine wave: 6 ms)                      |
|                            | Vibration resistance  | Functional  | 10 to 55 Hz at double amplitude of 2 mm (Detection time: 10μs)                   |
|                            |   | Destructive   | 10 to 55 Hz at double amplitude of 3 mm  |
| Expected life              | Mechanical  | Min. 10 <sup>6</sup> (at 180 times/min.)  |  |
|                            | Electrical  | Min. 5 × 10 <sup>4</sup> (at 8 A 250V AC, resistive load) (at 20 times/min.)  |  |
| Conditions                 | Conditions for operation, transport and storage*3 *4                            | Temperature: -40°C to +85°C <b>-40°F to +185°F</b> , Humidity: 5 to 85% R.H. (Not freezing and condensing at low temperature) |  |
|                            | Max. operating speed (at nominal switching capacity)                            | 20 times/min.   |  |
| Unit weight                |   | Approx. 8 g .28 oz  |  |

Notes: \*1. This value can change due to the switching frequency, environmental conditions, and desired reliability level, therefore it is recommended to check this with the actual load.

\*2. Wave is standard shock voltage of ±1.2×50μs according to JEC-212-1981

\*3. The upper limit of the ambient temperature is the maximum temperature that can satisfy the coil temperature rise value. Refer to Usage, transport and storage conditions in NOTES.

\*4. Allowable range when in original packaging is -40°C to +70°C **-40°F to +158°F**.

## REFERENCE DATA

### 1. Max. switching capacity (AC resistive load)

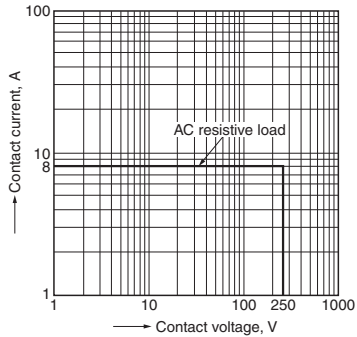

### 2. Set time

Tested sample: ADW1106, 15 pcs  
Ambient temperature: 28°C 82.4°F  
Contact load: 5V DC, 10mA

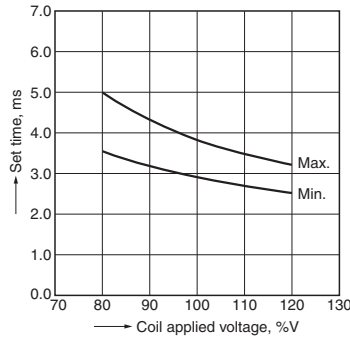

### 3. Reset time

Tested sample: ADW1106, 15 pcs  
Ambient temperature: 28°C 82.4°F  
Contact load: 5V DC, 10mA

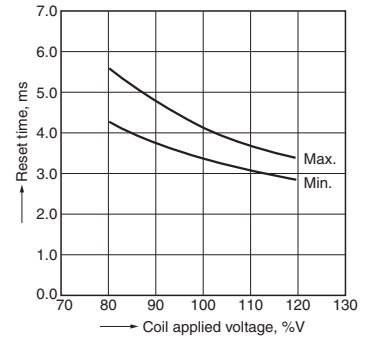

### 4. Ambient temperature characteristics

Tested sample: ADW1106, 6pcs  
Ambient temperature: -40°C to +85°C -40°F to +185°F

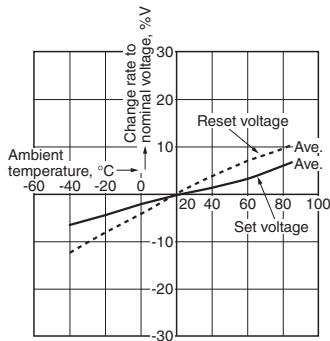

## DIMENSIONS (mm inch)

The CAD data of the products with a **CAD Data** mark can be downloaded from: <http://panasonic-electric-works.net/ac>

### CAD Data

### External dimensions

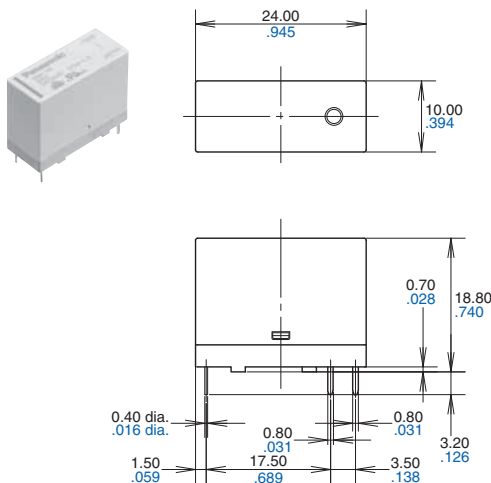

### PC board pattern (Bottom view)

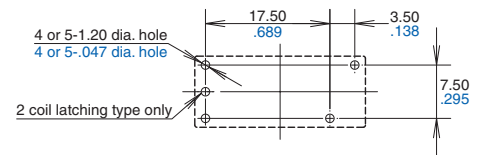

Tolerance:  $\pm 0.1 \pm .004$

### Schematic (Bottom view)

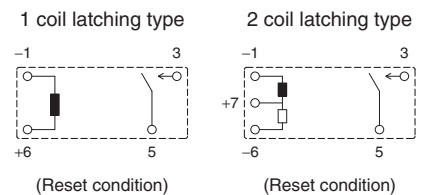

General tolerance:  $\pm 0.3 \pm .012$

## SAFETY STANDARDS

| Product name | UL/C-UL (Recognized) |   | VDE (Certified) |  |
|--------------|----------------------|---|-----------------|--|
|              | File No.             | Contact rating                                    | File No.        | Contact rating   |
| 1 Form A     | E43149               | 8A 250V AC R 85°C 185°F<br>5A 30V DC R 85°C 185°F | 40032254        | 8A 250V AC (cosφ=1.0) 85°C 185°F<br>5A 30V DC (0ms) 85°C 185°F |

Note: CSA standard; Certified by C-UL

# DW (ADW1)

## NOTES

### ■ Usage, transport and storage conditions

1) Temperature:

-40 to +85°C **-40 to +185°F** (Allowable range when in original packaging is -40 to +70°C **-40 to +158°F**.)

2) Humidity: 5 to 85% RH

(Avoid freezing and condensation.)

The humidity range varies with the temperature. Use within the range indicated in the graph below.

3) Atmospheric pressure: 86 to 106 kPa

Temperature and humidity range for usage, transport, and storage

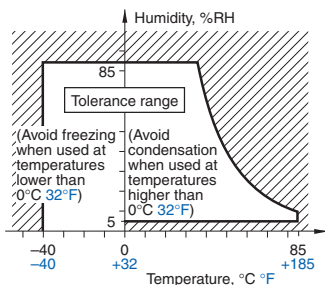

4) Condensation

Condensation forms when there is a sudden change in temperature under high temperature and high humidity conditions. Condensation will cause deterioration of the relay insulation.

5) Freezing

Condensation or other moisture may freeze on the relay when the temperature is lower than 0°C 32°F. This causes problems such as sticking of movable parts or operational time lags.

6) Low temperature, low humidity environments

The plastic becomes brittle if the relay is exposed to a low temperature, low humidity environment for long periods of time.

### ■ Solder and cleaning conditions

1) Flow solder mounting conditions

Please obey the following conditions when soldering automatically.

(1) Preheating: within 120°C **248°F** (solder surface terminal portion) and within 120 seconds

(2) Soldering iron: 260°C±5°C **500°F±41°F** (solder temperature) and within 6 seconds (soldering time)

\* Furthermore, because the type of PC board used and other factors may influence the relays, test that the relays function properly on the actual PC board on which they are mounted.

2) Reflow solder mounting (Pin-in-Paste mounting) conditions

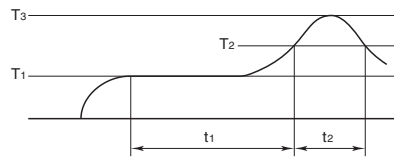

T<sub>1</sub> = 150 to 180°C **302 to 356°F**  
T<sub>2</sub> = 230°C **446°F** or more  
T<sub>3</sub> = 250°C **482°F** or less  
t<sub>1</sub> = 60 to 120 seconds  
t<sub>2</sub> = within 30 seconds

• Cautions to observe when mounting temperature increases in the relay are greatly dependent on the way different parts are located a PC board and the heating method of the reflow device. Therefore, please conduct testing on the actual device beforehand after making sure the parts soldered on the relay terminals and the top of the relay case are within the temperature conditions given above.

3) Since this is not a sealed type relay, do not clean it as is. Also, be careful not to allow flux to overflow above the PC board or enter the inside of the relay.

### ■ Cautions for use

1) For precautions regarding use and explanations of technical terminology, please refer to Group Catalog or our web site.

2) Since this relay is polarized, please observe the coil polarity (+ and -). Be sure to connect as shown in the attached product specifications diagram.

3) To ensure good operation, please keep the voltage on the coil ends to ±5% (at 20°C **68°F**) of the rated coil operation voltage.

Also, please be aware that the pick-up voltage and drop-out voltage may change depending on the temperature and conditions of use.

4) Keep the ripple rate of the nominal coil voltage below 5%.

5) The cycle lifetime is defined under the standard test condition specified in the JIS C 5442 standard (temperature 15 to 35°C **59 to 95°F**, humidity 25 to 75%). Check this with the real device as it is affected by coil driving circuit, load type, activation frequency, activation phase, ambient conditions and other factors.

Also, be especially careful of loads such as those listed below.

(1) When used for AC load-operating and the operating phase are synchronous. Rocking and fusing can easily occur due to contact shifting.

(2) Highly frequent load-operating

When highly frequent opening and closing of the relay is performed with a load that causes arcs at the contacts, nitrogen and oxygen in the air is fused by the arc energy and HNO<sub>3</sub> is formed. This can corrode metal materials.

Three countermeasures for these are listed here.

- Incorporate an arc-extinguishing circuit.
- Lower the operating frequency
- Lower the ambient humidity

6) Minimum switching capacity provides a guideline for low level load switching. This value can change due to the switching frequency, environmental conditions, and desired reliability level, therefore it is recommended to check this with the actual load.

7) Heat, smoke, and even a fire may occur if the relay is used in conditions outside of the allowable ranges for the coil ratings, contact ratings, operating cycle lifetime, and other specifications. Therefore, do not use the relay if these ratings are exceeded.

8) If the relay has been dropped, the appearance and characteristics should always be checked before use.

9) Incorrect wiring may cause unexpected events or the generation of heat or flames.

10) This relay can be oriented in any way when installing. However, the set/reset voltage and set/reset time, etc., may be affected slightly by the orientation due to the influence of gravitation. Therefore, when evaluating the relay, please do so with the relay placed in your intended orientation.

11) In order to maintain consistent set/reset pulse time of the latching type relay so that positive movement is ensured under ambient temperature fluctuations and other usage conditions, we recommend that you keep the coil applied set/reset pulse width to 30 ms or higher using the nominal coil voltage.

12) Relays are shipped in a 'reset' state. During shipping and handling, however, shocks may change the state to 'set.' Consequently, at time of use (at power on) it is recommended to ensure that circuits are returned to the desired state ('set' or 'reset').

13) Do not use parts that generate organic silicon. When present in the vicinity, conduction failure may occur.

# Panasonic Electric Works Co., Ltd.

Automation Controls Business Unit

■ Head Office: 1048, Kadoma, Kadoma-shi, Osaka 571-8686, Japan

■ Telephone: +81-6-6908-1050 ■ Facsimile: +81-6-6908-5781

panasonic-electric-works.net/ac

All Rights Reserved © 2011 COPYRIGHT Panasonic Electric Works

Specifications are subject to change without notice.

ASCTB8E 201107-2YT

Printed in Japan.